



Yealink W60 IP DECT phone

A guide to using your phone with Cloud Voice



What can this guide help you with?

Make sure you can successfully call
emergency services

1. Check out everything in the box

What's in the box? You'll unpack:



W56H handset



W60B base station

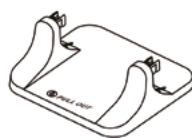

Base stand

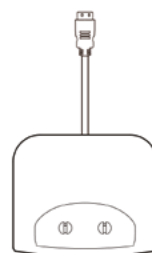

USB charger cradle

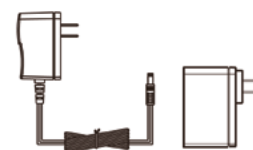

2 power adapters



Ethernet cable

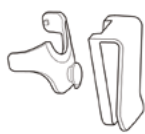

Belt clip



Rechargeable battery

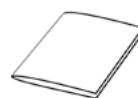

Quick start guide



Handset protective case
(optional)

Note: the Yealink W60 DECT IP phone includes one W56H handset and one W60B base station.

And, if you took a separate handset package, you'll have another:



W56H handset

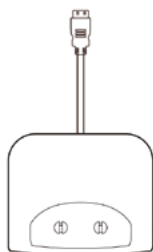

USB charger cradle



Belt clip



Power adapter



Rechargeable battery



Handset protective case (optional)

2. Set up your phone in three steps

To start using your phone, you should:

1. get your base station working
2. power up your USB charger
3. charge your phone.

Step one: Get your base station working

Your base station can use AC power or power over Ethernet.
Ask your IT team what's best for you.

To connect to AC power:

- I. take the Ethernet cable and plug it into your base station
- II. plug the other end of the Ethernet cable into your hub or switch
- III. then connect the power adaptor to your base station.

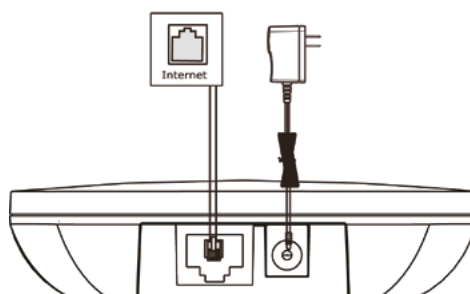

To connect to power over Ethernet:

- I. check your hub or switch is up to IEEE 802.3af standards
- II. take the Ethernet cable and plug it into your base station
- III. plug the other end of the Ethernet cable into your hub or switch.

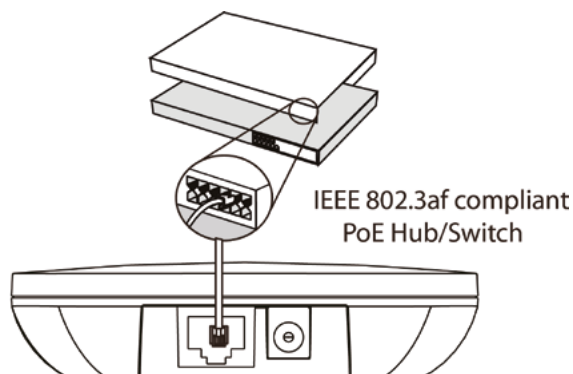

You can set up your base station to stand by itself. To do this:

- I. connect the cables
- II. snap the stand into place at the back of the base station.

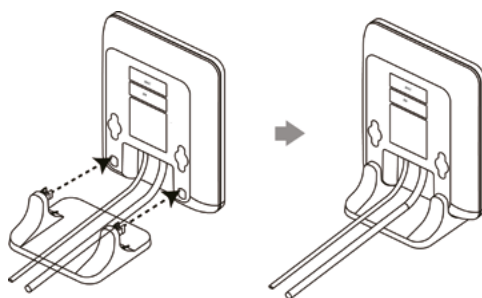

Or keep it out the way by mounting it on the wall:

- I. get two screws
- II. drive them into your wall, 59mm apart
- III. then hang the base station on the screws.

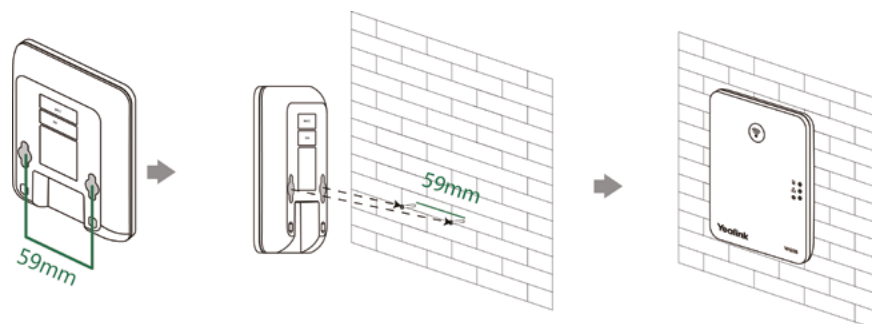

Step two: Power up your USB charger

Think about where you're most likely to take calls in your office. Plug your charger into the nearest outlet. To do this:

- I. set the USB charger on a desk or mount it on the wall using two screws – driven into the wall 36mm apart

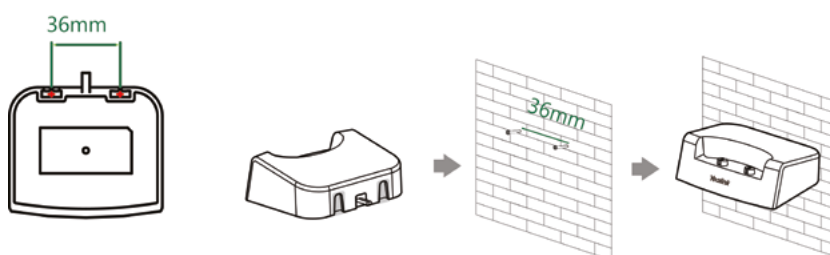

- II. connect the charger's USB to the power adapter
- III. plug the power adapter into the outlet.

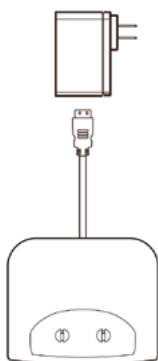

Note: The Yealink power adapter is designed to be used with the handset. Other adapters could damage your phone.

Step three: Charge your phone

It takes three hours to fully charge the handset. To start charging:



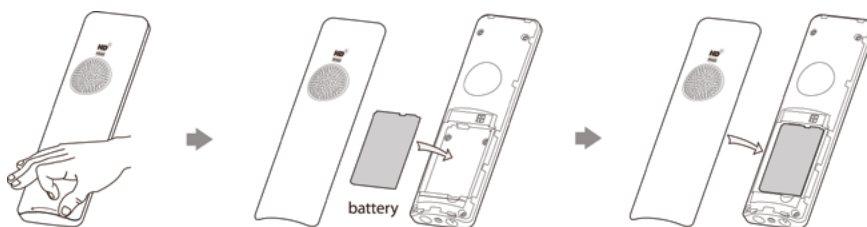

- I. put batteries into the back of the handset
- II. turn the handset on

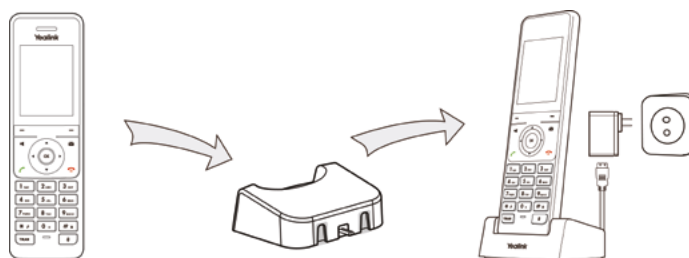

- III. sit the handset in the USB charger



IV. look for the battery status at the top of your phone's screen.

Charging status	Icon
Fully charged	
80% charged	
60% charged	
40% charged	
20% charged	

Note: Turn off the handset before taking out its battery or you risk losing data. And don't use a damaged battery.

And here's how to use the belt clip

If you need your hands free at work, the belt clip's the best way to keep your phone by your side. Attach it to the back of your handset by:

- I. pushing part of the clip into the notch at the back of the handset
- II. then slotting the rest of the clip onto the phone.

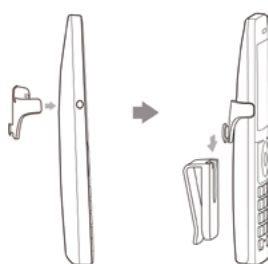

3. Get to know each part of your phone



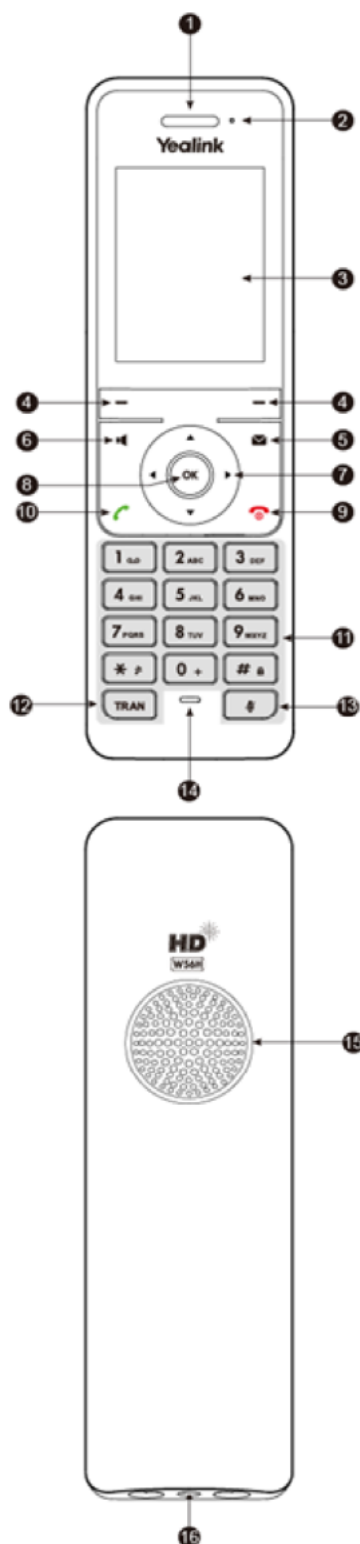



Your handset



1	Listen to calls using the earpiece .
2	The flashing light tells you when something's going on. <ul style="list-style-type: none"> • Fast red flashes = there's an incoming call. • Slow red flashes = you have a voicemail or missed call. • Solid red light = the handset's battery is charging.
3	Find out more about the screen from page 9.
4	These soft keys help you use the phone's features.
5	The message button opens your voicemail and missed calls.
6	Place a call on speakerphone . <ul style="list-style-type: none"> • Switch from the earpiece or a headset. • Answer a call on speakerphone.
7	The directional arrows help you navigate menus. <ul style="list-style-type: none"> • Take shortcuts. • Scroll through information. • Move the cursor. • Adjust the volume. • Switch between values.
8	Confirm action or go to the main menu with the OK button.
9	This button ends calls and turns on the handset. <ul style="list-style-type: none"> • Press once to go back a step. • Press and hold to return to the home screen. • When off, press to turn the phone on. • While on the home screen, press to turn the phone off. • Cancel an action or end a call. • Reject an incoming call.
10	Answer an incoming call with the off-hook button . <ul style="list-style-type: none"> • Enter the redial call list. • Switch to the earpiece or a headset.
11	Dial numbers with the keypad .
12	Transfer a call to another number with the TRAN button.
13	Stop being heard by pressing the mute button .
14	Speak into the microphone .
15	Listen to calls hands-free over the speaker .
16	Connect a headset through the 3.5mm headset connection .



Your home screen





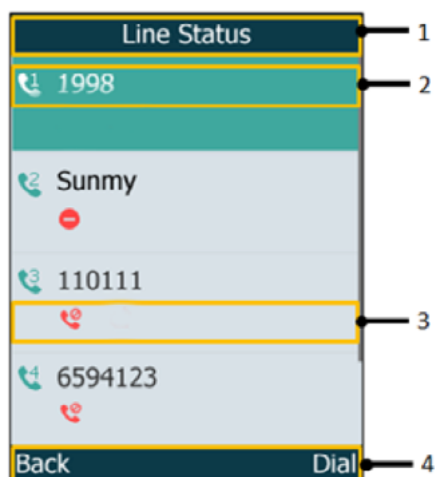













1	<p>Check your reception using the signal strength icon.</p> <ul style="list-style-type: none"> No reception =  Weak reception =  Strong reception =  Eco mode = 
2	Find your feature status here.
3	<p>See how much charge you have left using the battery charge icon.</p> <ul style="list-style-type: none"> Extremely low battery =  Low battery =  High battery = 
4	Look at the time and date .
5	Find out which handset you're using by reading its name and number .
6	The default soft key labels are History and Line .

Line status screen



1	This is the menu name .
2	<p>Find out the registered line number and corresponding line.</p> <ul style="list-style-type: none"> This is your DDI number by default. The default outgoing line displays on the first line of the screen.
3	The line status icon tells you whether a feature's assigned to the line.
4	The two soft key labels .

Screen icons

	Here are your registered handsets and their numbers.
	Earpiece mode is on.
	Headset mode is on.
	You're using the speakerphone.
	The keypad is locked.
	There's a voicemail.
	You're using silent mode.
	This is a contact.
	This is a received call.
	This is a missed call.
	This is a placed call.
	This call is on hold.
	You are muted.
	Do not disturb.
	This is an intercom call.
	This is an unassigned outgoing line.
	This is an anonymous call.
	Reject the anonymous call.

Your base station

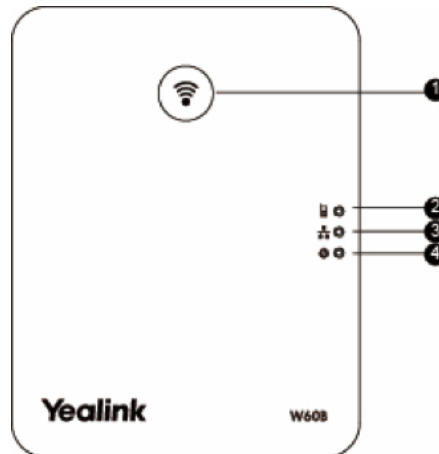

1	<p>Press the paging key to make your handset ring when you can't find it.</p> <ul style="list-style-type: none"> • Toggle through the registration mode. • Reset the base station to its factory settings.
2	<p>Check the base station's mode with the registration LED.</p> <ul style="list-style-type: none"> • Fast green flashes = the station's in paging mode. • Slow green flashes = the station's in registration mode. • Steady green light = a handset is registered to the base station. • No light = there's no registered handsets.
3	<p>Find out if it's connected to the internet with the network status LED.</p> <ul style="list-style-type: none"> • Slow green flashes = the station's offline. • Steady green light = the station's connected to the internet.
4	<p>Make sure you have power with the power indicator LED.</p> <ul style="list-style-type: none"> • Slow green flashes = the station's upgrading firmware. • Steady green light = the station has power. • No light = the station doesn't have power.

Note: If you've set up the base station and registered a handset successfully, all LEDs will show green.



How to register a new handset

The handset that came with the Yealink W60 DECT IP phone is already registered.

But you'll need to register a separate handset package to a base station. You can tell if the screen says 'Press base paging 2s then press OK'. To register it:

- I. press and hold the  button on the base station until the registration LED flashes
- II. press the 'Reg' soft key on the handset.

If this doesn't work, try registering from the handset:

- I. press 
- II. select 'Register Handset'
- III. choose your base station from a list of nearby devices then press 
- IV. once the handset's found it, press  again.
- V. Enter the base station PIN (default: 0000)
- VI. press the 'Done' soft key to finish registering the handset.

The handset screen will briefly show 'Handset Subscribed' and 'Base NOXXXX' (the last 4 characters of the connected base station's unique MAC address). Once registered, its name and number will show on the home screen.

4. How to handle calls



Make a call

There are a few ways to ring someone.

To call a new contact

- I. dial their number
- II. press .



To call a contact in your directory

- I. while on the home screen, press .
- II. select 'Phonebook'
- III. choose the contact you want to call
- IV. press .

To call a number from your call history

- I. press the 'History' soft key
- II. choose the number you want to ring
- III. press .

To call a number from your redial list

- I. while on the home screen, press .
- II. choose the number you want to ring
- III. press .

To make a call on speakerphone

- I. dial the number
- II. press .

Answer a call

When someone rings you, the call will appear on the screen of your handset. It will tell you how long you've been talking and give you details about the caller.

To answer a call with the earpiece

- I. press  or the 'Accept' soft key.

To answer a call on speakerphone



- I. press .

To answer a call when you've connected a headset to your phone

- I. answer with the 'Accept' soft key.

Note: you can ignore an incoming call by pressing the 'Silence' soft key or reject it by pressing the off-hook key.

To answer when you're on another call

- I. select the incoming call with .
- II. with the earpiece, press  or the 'Accept' soft key
- III. on speakerphone press .



End a call

You can hang up by pressing  or the 'End' soft key.



Transfer a call

There are a couple of ways to do this.

The simplest way to transfer a call is to:

- I. press  during a call
- II. dial the number you want to transfer the call to
- III. press .

If you want to make sure the call's answered once you've passed it along, transfer by:

- I. press  during a call
- II. dial the number you want to transfer the call to
- III. press  to dial out
- IV. press  when you hear the ring tone or wait until the call's answered.

5. How to solve problems

How do I restore power to the base station?

- Check your setup using page 4.
- If you're using AC power, try plugging the power adaptor into another socket.
- If you're using power over Ethernet, connect the base station directly to your LAN switch. If there's no power light on the base station get in touch with your LAN provider if it's not part of your Cloud Voice service.
- If you still need help, just call us on **0800 389 0537**.

How do I check a handset's registered with a base station?

- Press the paging key (☎) on the base station. If your handset rings it's registered with the station.
- If the handset has 'Unregistered' written on its screen, follow the steps on page 10 to register.

How do I check a base station's connected to my network?

Press the paging key (☎) on the base station. You'll see the IP address on the screen. If it says '0.0.0.0.', it isn't connected. Your IT team should be able to help.

Can I check my line status from a handset?

Yes. Press the 'Line' soft key on your handset. You'll see your number at the top of the 'Line Status' screen. If you see a red cross by it, your line isn't working. You'll need to check your phone's registered to the user on the business portal.

I can make calls but people can't call me. What's gone wrong?

Check if your handset is set to 'Do not disturb'. Look for  by the signal indicator. Dialling *79 on your keypad will turn this off.

My phone still isn't working

Don't worry. We should be able to help. Call us on **0800 389 0537**.

Make sure you can successfully call emergency services

Keep your address updated

Your Cloud Voice number's registered to a specific address. When you make a 999 or 112 call from your phone number, that's the address emergency services will see.

We don't update your address automatically. So please tell us if you start using Cloud Voice in a different location.

You might not be able to make 999 or 112 calls when your internet network is down or during a power cut. Or if you're using Cloud Voice from an app.

Offices Worldwide

The services described in this publication are subject to availability and may be modified from time to time. Services and equipment are provided subject to British Telecommunications plc's respective standard conditions of contract. Nothing in this publication forms any part of any contract.

© British Telecommunications plc 2018. Registered office: 81 Newgate Street, London EC1A 7AJ. Registered in England No. 1800000.

July 2018

