



Yealink W53P Wireless DECT Phone

A guide to using your phone with Cloud Voice

Contents

What's in the box?	3
Let's get started	4
Check you're set up on Cloud Voice	9
Getting to know your phone	10
Phone display	11
Using your phone	15
Troubleshooting	16
General information	17

What's in the box?

We're here to help you get the best out of your new phone. Just follow the instructions below. Here's what you should find when you open the box.

Got everything?

- Yealink W60B DECT base (pictured)
- Yealink W53H Additional handset (pictured)
- Ethernet cable
- Quick start guide
- Base stand
- 2 x Power adaptors
- Belt clip
- Rechargeable battery
- USB charger cradle

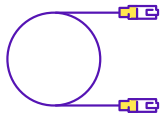

Ethernet cable

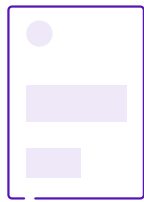

Quick start guide

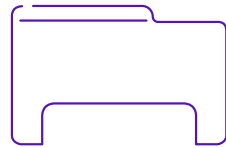

Base stand



2 x Power adaptors

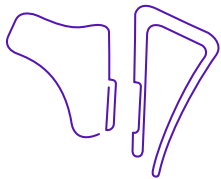

Belt clip



Rechargeable battery

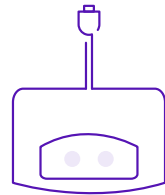

USB charger cradle



Yealink W53P handset and Yealink W60B DECT base

Let's get started

Set up your phone

To start using your phone, you need to get your base station working, power up your USB charger, and charge your phone. Here's how.

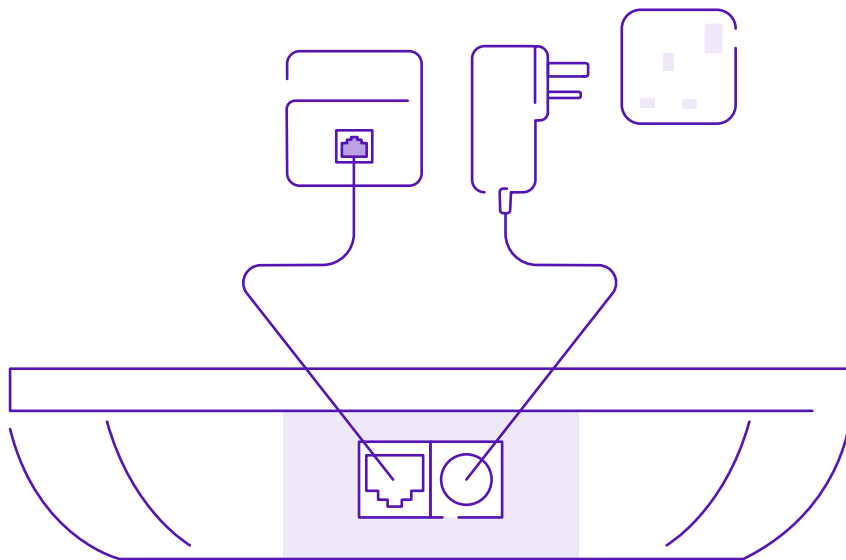

Get your base station working

Your base station can use AC power or Power over Ethernet (PoE). Ask your IT team what's best for you.

To connect to AC power:

- Take the Ethernet cable and plug it into your base station.
- Plug the other end of the Ethernet cable into your hub or switch.
- Connect the power adaptor to your base station.

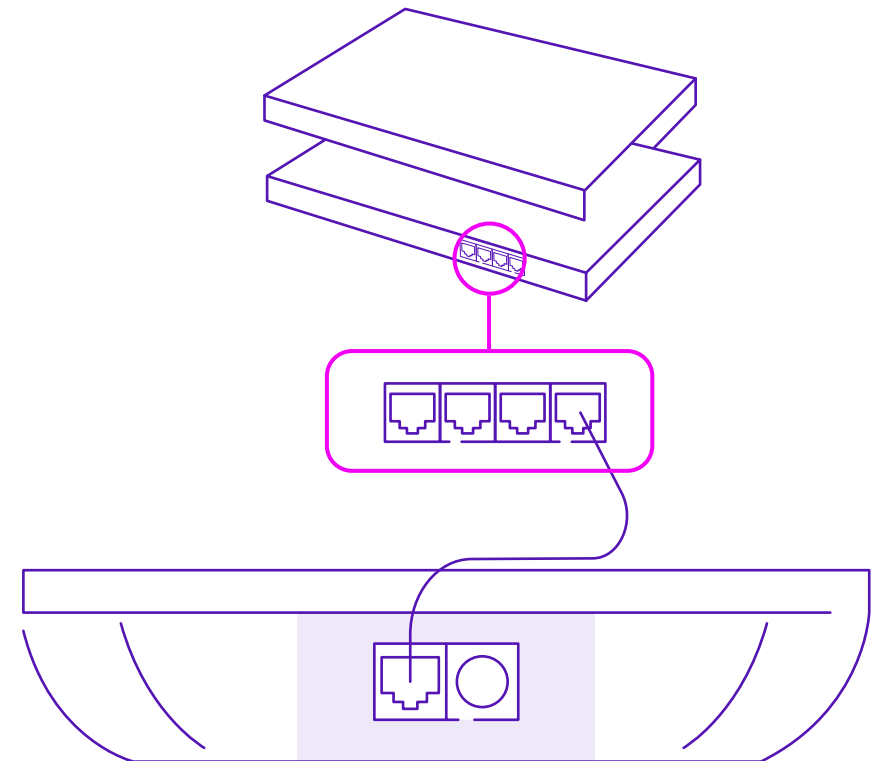

To connect to PoE:

- Check your hub or switch is up to IEEE 802.3af standards – see your user guide or refer to the manufacturer if you're unsure.
- Take the Ethernet cable and plug it into your base station.
- Plug the other end of the Ethernet cable into your hub or switch.

You can set up your base station to stand by itself. To do this, connect the cables, then snap the stand into place at the back of the base station.

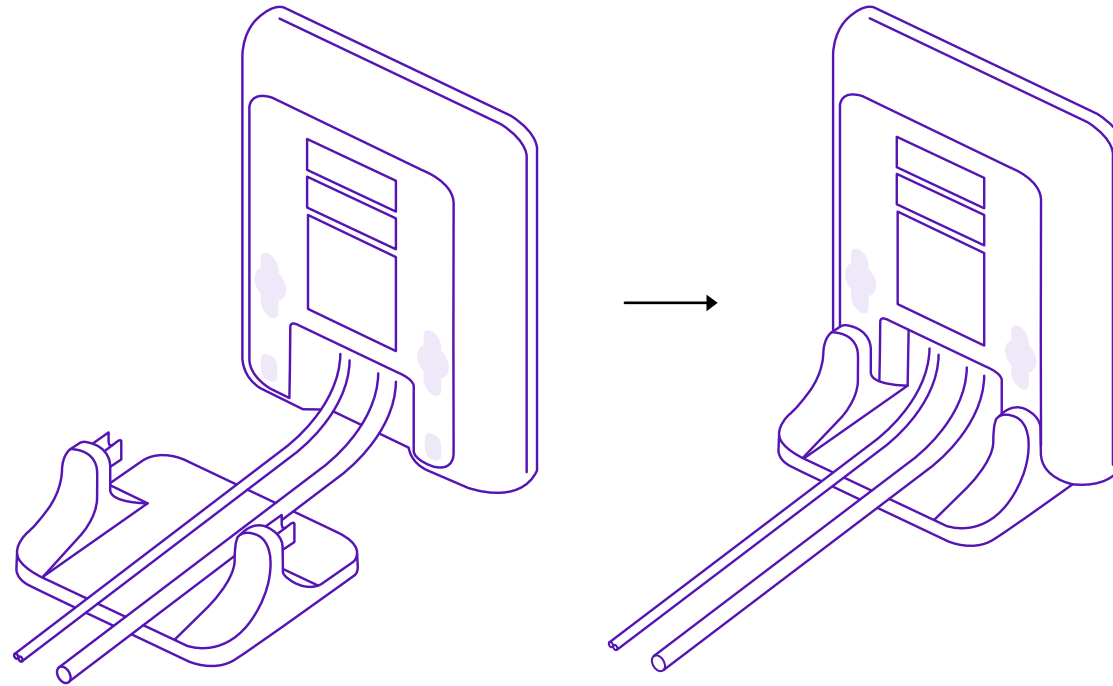

Alternatively, you can mount your base station on a wall. Take two screws, drive them into your wall 59mm apart, then hang the base station on the screws.

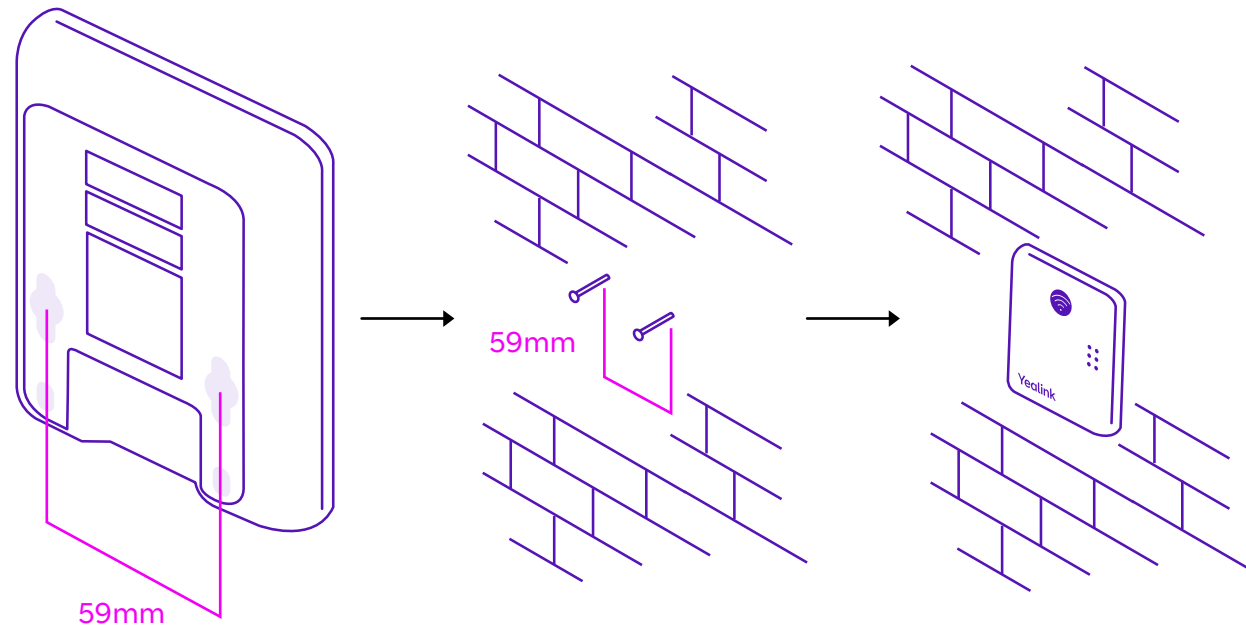

Power up your USB charger

It's a good idea to have your charger close to where you're most likely to take calls in your office. Plug your charger into the nearest outlet - set the USB charger on a desk or mount it on the wall using two screws, driven into the wall 36mm apart.

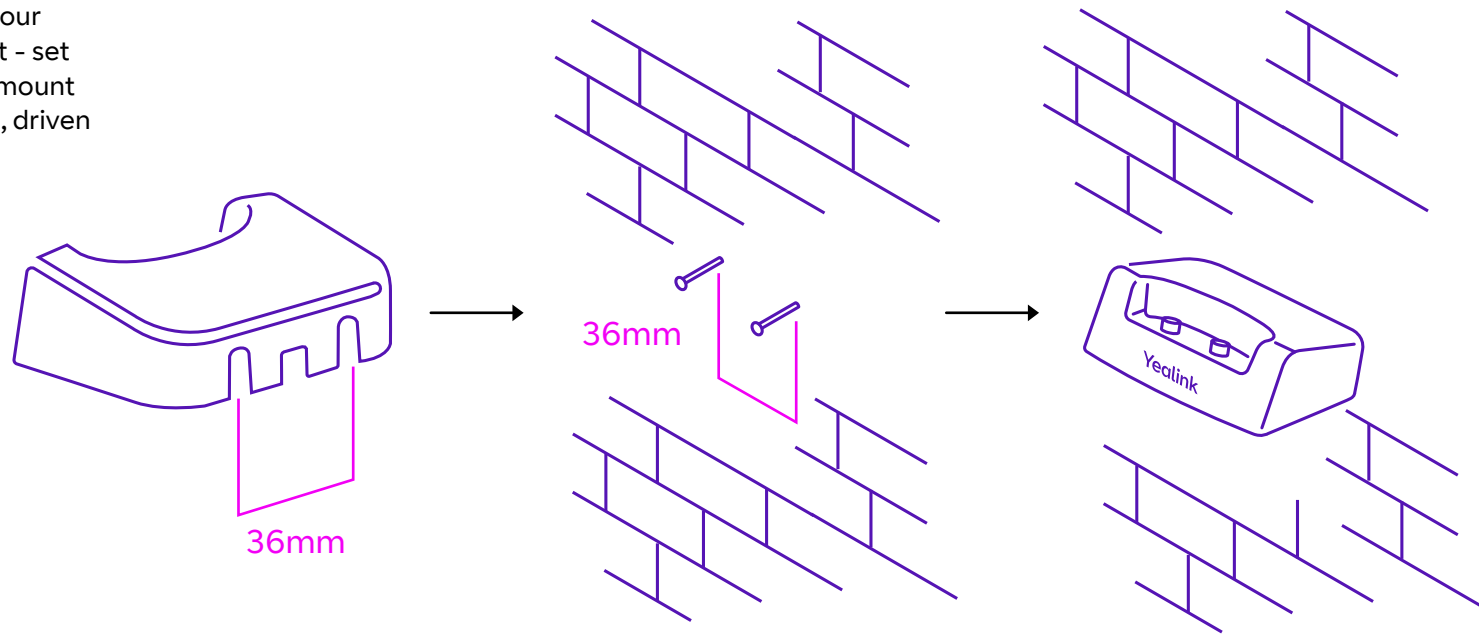

Then, connect the charger's USB to the power adapter, and plug the power adapter into the outlet.

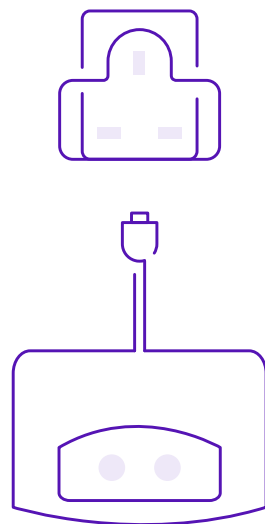

Charge your phone

It takes three hours to fully charge the handset. To start charging, put batteries into the back of the handset, then turn it on.

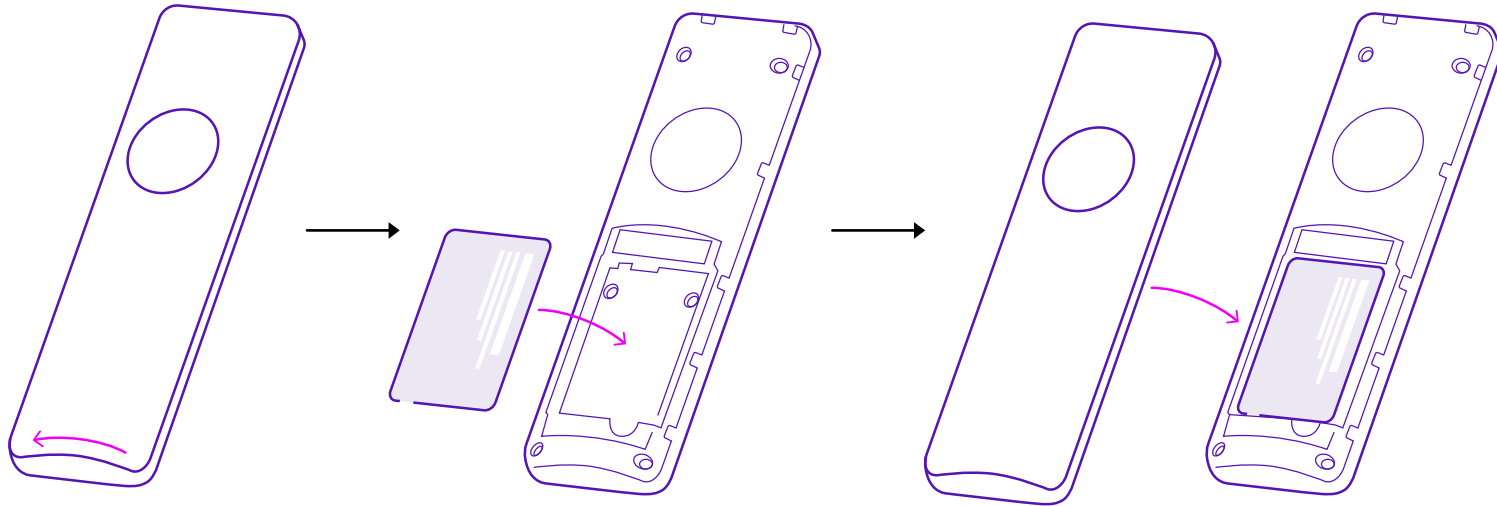

Then place the handset into the USB charger.

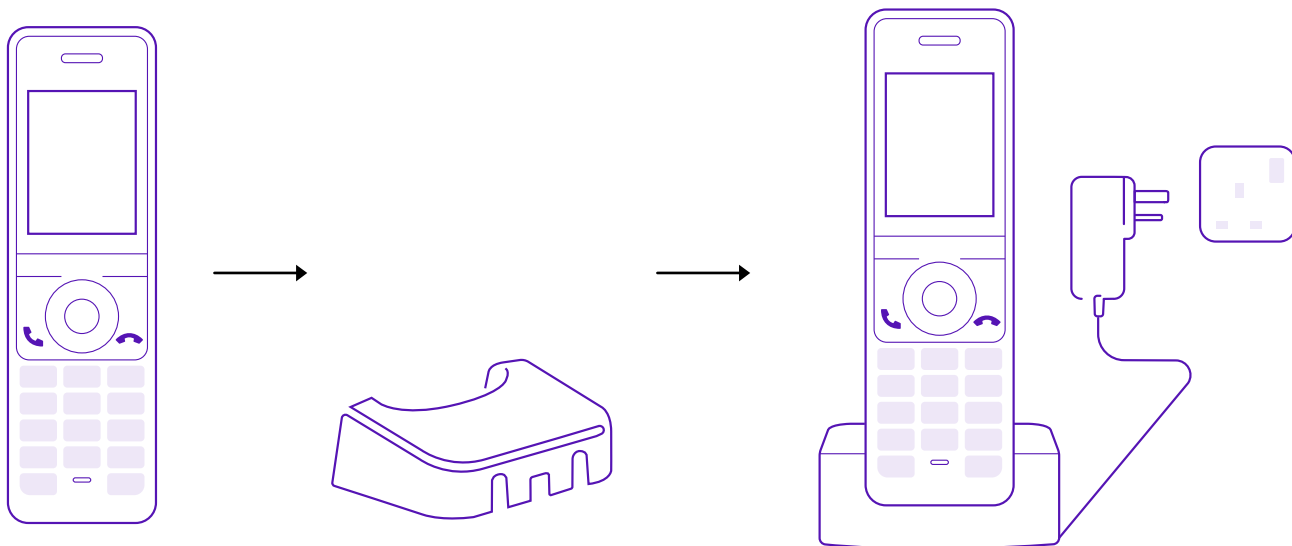

As it charges, you'll see your phone's battery status at the top of its screen.

Fully charged 

80% charged 

60% charged 

40% charged 

20% charged 

Note: Turn off the handset before taking out its battery or you risk losing data. And don't use a damaged battery.

And here's how to use the belt clip

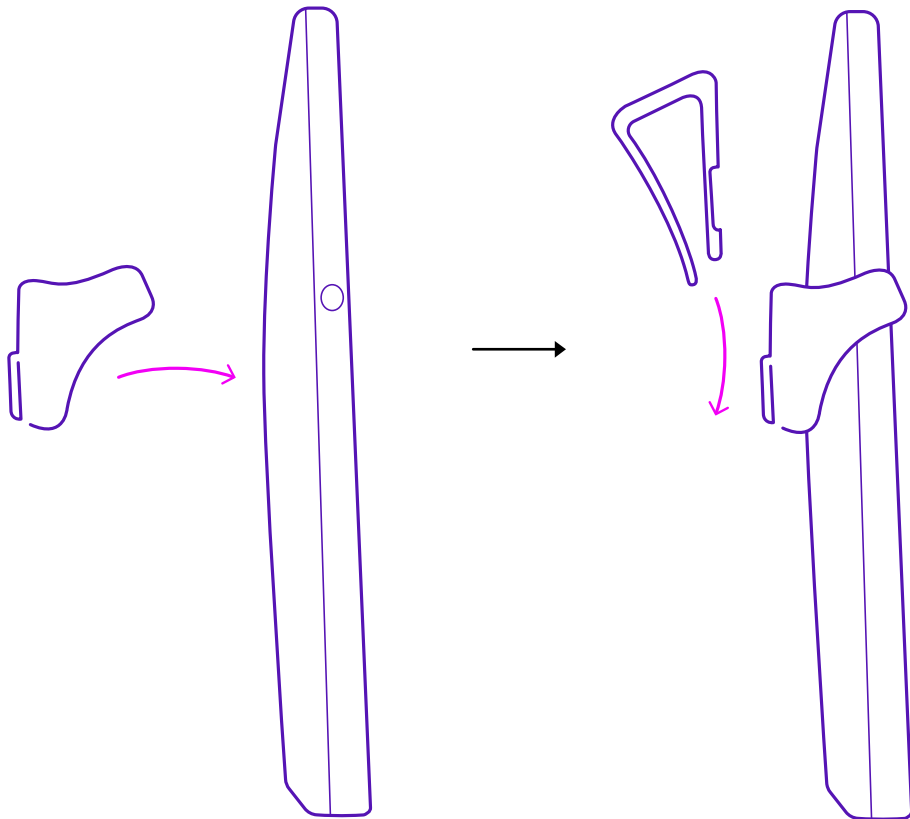

If you need your hands free at work, the belt clip's the best way to keep your phone by your side. Attach it to the back of your handset by pushing part of the clip into the notch at the back of the handset, then slotting the rest of the clip onto the phone.



Check you're set up on Cloud Voice

Your phone comes with everything you need to get set up on Cloud Voice.

Once your phone's connected to the network, it'll update its firmware. This might take some time, so please be patient.

Once it's finished, it'll show this symbol:  If something has gone wrong, you'll see this symbol .

If this happens, just give us a call on **0800 389 0537** and we'll be able to help.

Once everything is updated and ready to go, your Cloud Voice number will show on the screen.

Getting to know your phone

Phone features and keys

1	Listen to calls using the earpiece . The flashing light tells you when something's going on.
2	<ul style="list-style-type: none"> Fast red flashes = there's an incoming call. Slow red flashes = you have a voicemail or missed call. Solid red light = the handset's battery is charging.
3	Find out more about the screen from pages 11 & 12.
4	These soft keys help you use the phone's features.
5	The message button opens your voicemail and missed calls Make a call using the speakerphone .
6	<ul style="list-style-type: none"> Switch from the earpiece or a headset. Answer a call on speakerphone.
7	The directional arrows help you navigate menus. <ul style="list-style-type: none"> Take shortcuts. Scroll through information. Move the cursor. Adjust the volume. Switch between values.
8	Confirm an action or go to the main menu with the OK button. This button ends calls and turns on the handset. <ul style="list-style-type: none"> Press once to go back a step. Press and hold to return to the home screen.
9	<ul style="list-style-type: none"> When off, press to turn the phone on. While on the home screen, press to turn the phone off. Cancel an action or end a call. Reject an incoming call.
10	Answer an incoming call with the off-hook button . <ul style="list-style-type: none"> Enter the redial call list. Switch to the earpiece or a headset.
11	Dial numbers with the keypad .
12	Transfer a call to another number with the TRAN button.
13	Stop being heard by pressing the mute button .
14	Speak into the microphone .
15	Listen to calls hands-free over the speaker (back of handset).
16	Connect a headset through the 3.5mm headset connection .



Phone display

Home screen



Check your reception using the signal strength icon.

- 1
- No reception =
 - Weak reception =
 - Strong reception =
 - Eco mode =

2 Find your **feature status** here.

See how much charge you have left using the battery charge icon.

- 3
- Extremely low battery =
 - Low battery =
 - High battery =

4 Find out which handset you're using by reading its name and number.

6 Find out which handset you're using by reading its **name and number**.

6 The default **soft key labels** are **History** and **Line**.

Line Status screen

You can reach the Line Status screen by pressing the **Line** soft key on the **Home** screen.

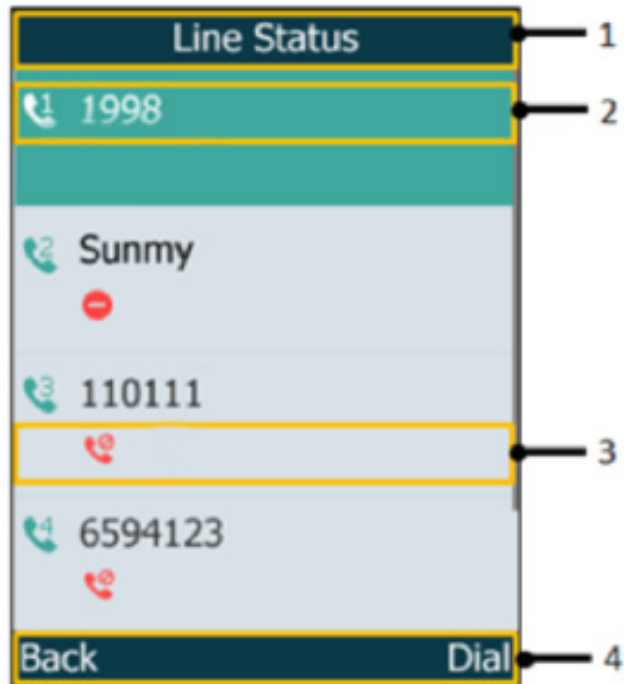

1 This is the **menu name**.

Find out the **registered line number and corresponding line**.

- 2
- This is your DDI number by default.
 - The default outgoing line displays on the first line of the screen.

3 The **line status icon** tells you whether a feature's assigned to the line.

4 The two **soft key labels**.

Understanding your screen icons

	Your registered handsets and their numbers
	Earpiece mode is on
	Headset mode is on
	You're using the speakerphone
	The keypad is locked
	You have voicemail
	You're using silent mode
	This is a contact
	This is a received call
	This is a missed call
	This is a placed call
	This call is on hold
	You are muted
	Do not disturb is switched on
	This is an intercom call
	This is an unassigned outgoing line
	This is an anonymous call
	Reject the anonymous call

Your base station

-
- 1 Press the paging key to make your handset ring when you can't find it.
- Toggle through the registration mode.
 - Reset the base station to its factory settings.
-

- 2 Check the base station's mode with the registration LED.
- **Fast green flashes** = the station's in paging mode.
 - **Slow green flashes** = the station's in registration mode.
 - **Steady green light** = a handset is registered to the base station.
 - **No light** = there's no registered handsets.
-

- 3 Check your base station's connected to the internet with the network status LED.
- **Slow green flashes** = the station's offline.
 - **Steady green light** = the station's connected to the internet.
-

- 4 Check power with the power indicator LED.
- **Slow green flashes** = the station's upgrading its firmware.
 - **Steady green light** = the station has power.
 - **No light** = the station doesn't have power.
-

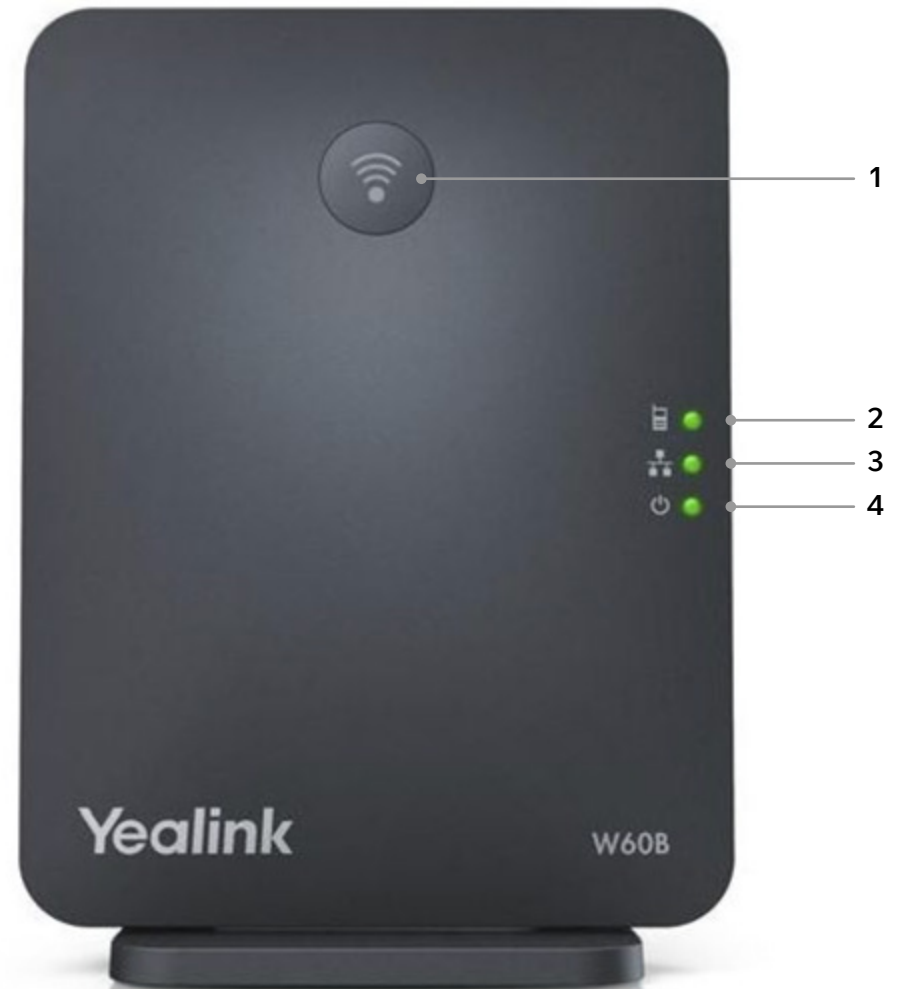



How to register a new handset

The handset that came with your Yealink W53P DECT IP phone is already registered. But you'll need to register any separate handset to a base station - you'll know you need to do this if the screen says 'Press **base paging 2s** then press **OK**'.

To register a handset:

- Press and hold the  button on the base station until the registration LED flashes
- Press the **Reg** soft key on the handset.

If this doesn't work, try registering from the handset:

- Press 
- Select **Register Handset**.
- Choose your base station from a list of nearby devices then press 
- Once the handset's found it, press  again.
- Enter the base station PIN (default: 0000).
- Press the **Done** soft key to finish registering the handset.

The handset screen will briefly show '**Handset Subscribed**' and '**Base NOXXXX**' - the 'X's represent the last four characters of the connected base station's unique Media Access Control, or MAC, address, so you know which of your base stations

the handset is connected to. Once registered, its name and number will show on the home screen.

Note: If you've set up the base station and registered a handset successfully, all LEDs will show green.



Using your phone



Making calls

You can use your Yealink W53P to make calls in various ways.

To call a new contact

- Dial their number
- Press 



To call a contact in your directory

- While on the Home screen, press 
- Select **Phonebook**
- Choose the contact you want to call
- Press 

To call a number from your call history

- Press the **History** soft key
- Choose the number you want to ring
- Press 

To call a number from your redial list

- While on the Home screen, press 
- Choose the number you want to ring
- Press 

To make a call on speakerphone

- Dial a number
- Press 

Answering calls

When someone rings you, the call will appear on the screen of your handset. You'll also see the caller's details, and how long you've been talking.

To answer a call with the earpiece

- Press  or the **Accept** soft key.

To answer a call on speakerphone

- Press 



To answer a call when using a headset

- Press the **Accept** soft key.

Note: you can ignore an incoming call by pressing the **Silence** soft key, or reject it by pressing the off-hook key.

To answer a call when you're on another call

- Select the incoming call with 

- If using the handset or a headset, press  or the **Accept** soft key
- If you're on speakerphone, press 

Transferring calls

You can transfer a call to another person in one of two ways. The simplest way is as follows:

- Press **TRAN** during a call
- Dial the number you want to transfer the call to
- Press **TRAN** again to complete the transfer.

The call will then be connected to the number you're transferring it to.

If you want to make sure the call's answered once you've passed it along, you need to:

- Press **TRAN** during a call
- Dial the number you want to transfer the call to
- Press  to dial out
- When you hear the target phone ringing or it's answered, press **TRAN** again to complete the transfer.

Ending calls

You can hang up by pressing  or the **End** soft key.

Troubleshooting

How do I restore power to the base station?

- Check you're set up correctly, using [page 4](#) for reference.
- If you're using AC power, try plugging the power adaptor into another socket.
- If you're using power over Ethernet, connect the base station directly to your LAN switch. If there's no power light on the base station get in touch with your LAN provider, if it's not part of your Cloud Voice service.
- If you still need help, just call us on **0800 389 0537**.

How do I check a handset's registered with a base station?

- Press the paging key  on the base station. If your handset rings, it's registered with the station.
- If the handset shows Unregistered on its screen, follow the steps on [page 4](#) to register.

How do I check a base station's connected to my network?

Press the paging key  on the base station. You should see your IP address on the screen. If it says '**0.0.0.0**', it isn't connected. Your IT team should be able to help.

Can I check my line status from a handset?

Yes. Press the **Line** soft key on your handset. You'll see your number at the top of the **Line Status screen**. If you see a red cross next to it, your line isn't working. You'll need to check your phone's registered to the user on the business portal.

I can make calls, but people can't call me. What's gone wrong?

Your handset could be set to **Do not disturb**. Look for by the signal indicator . Dialling *79 on your keypad will turn this off.

My phone still isn't working

Don't worry. We should be able to help. Call us on **0800 011 3237**, any time between 8am and 6pm.

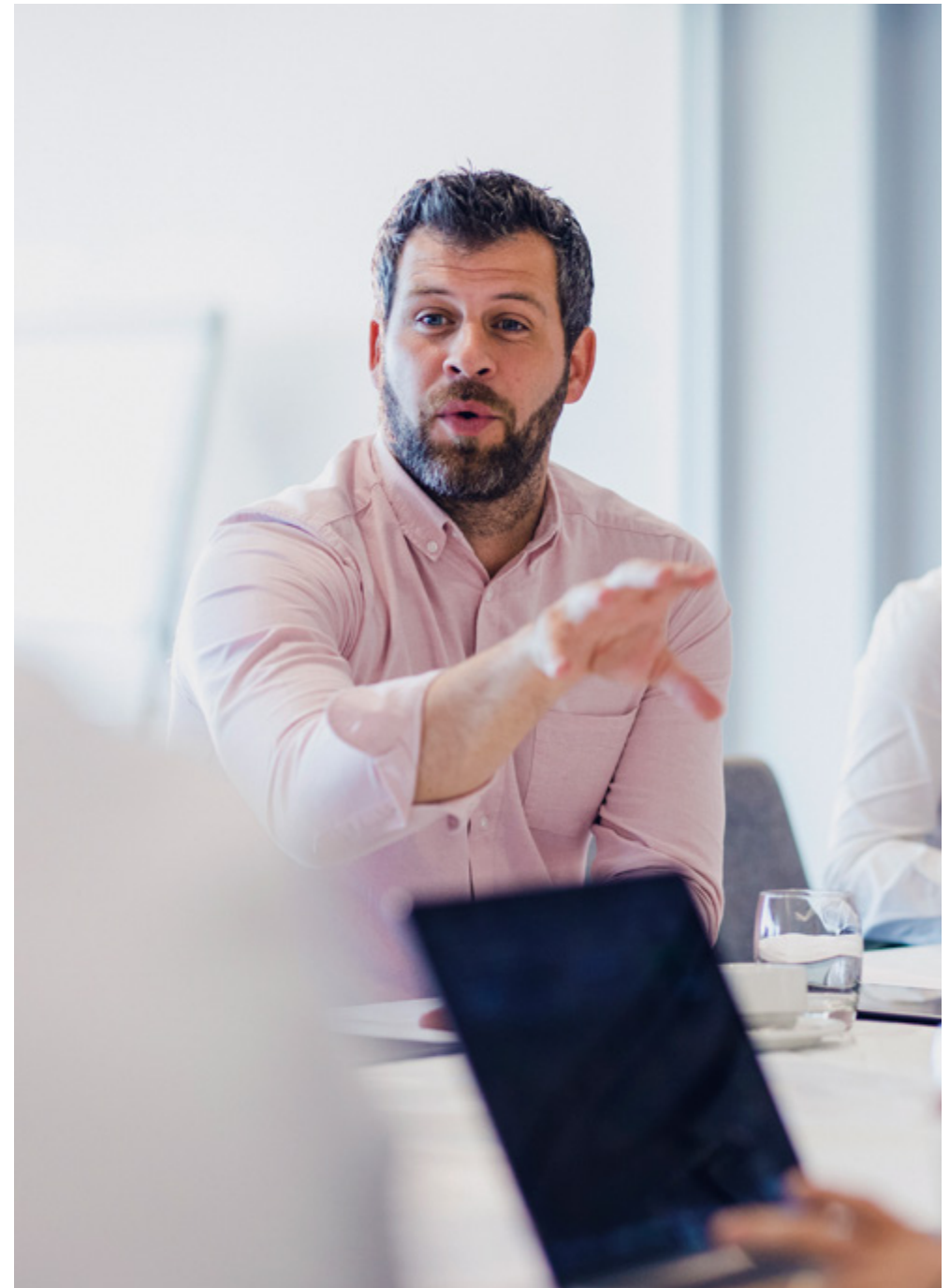

General information

Important – 999 or 112 emergency calls

- Your Cloud Voice number is registered to a specific address, so when you make a 999 or 112 call from your phone number, that's the address the emergency services will see.
- If you use Cloud Voice at a different address, the registered address won't automatically change. So if your work location changes, please let your administrator know so they can update your registered address.
- You might not be able to make 999 or 112 calls if there's a power or network failure, or you're using the service from an app or mobile phone.

Safety information

Do not open the handset or the base.

This could expose you to high voltages or other risks. If your phone needs to be repaired, call us on 0800 389 0537 and we'll be able to help.



Cleaning

Clean the handset and base with a damp (not wet) cloth, or an antistatic wipe. Never use household polish as this will damage the product. Never use a dry cloth as this may cause a static shock.

Environmental

- Do not expose to direct sunlight.
- Make sure your phone is on a dry, flat surface, not on a carpet or anything which has fibres. Make sure it can always get a free flow of air over its surfaces.
- Do not submerge any part of your product in water and do not use it in damp or humid conditions, such as bathrooms.
- Do not expose your product to fire, explosive or other hazardous conditions.
- There's a slight chance your phone could be damaged by an electrical storm. Should this happen, contact your BT service desk.

Product disposal instructions

- The symbol shown here  and on your phone means your product is classed as  electrical or electronic equipment. You shouldn't throw it away with other office waste once at the end of its working life.
- The Waste of Electrical and Electronic Equipment (WEEE) Directive (2002/96/EC) has been put in place to recycle products using best available recovery and recycling techniques to minimize the impact on the environment, treat any hazardous substances and avoid the increasing landfill.
- Business users should contact their suppliers and check the terms and conditions of the purchase contract and ensure that this product is not mixed with other commercial waste for disposal.

Guarantee

Your Yealink W53P is guaranteed for a period of 12 months from the date of purchase. Your guarantee covers the repair or replacement of your phone or any of its parts (other than batteries) if they're faulty or below standard, or they break because of bad workmanship or materials. If your product is more than 28 days old, it might be replaced with a refurbished or repaired product.

The conditions of this guarantee are:

- The guarantee shall only apply to defects that occur within the 12-month guarantee period.
- You provide proof of purchase.
- You'll need to return your phone to us according to our instructions.
- We don't cover any faults or problems that are caused by accidents, misuse, fair wear and tear, neglect, or if you've tried to repair the equipment yourself.

This guarantee does not affect your statutory rights.



Offices worldwide

The services described in this publication are subject to availability and may be modified from time to time. Services and equipment are provided subject to British Telecommunications plc's respective standard conditions of contract. Nothing in this publication forms any part of any contract.

© British Telecommunications plc 2021. Registered office: 81 Newgate Street, London EC1A 7AJ. Registered in England No. 1800000.

September 2021