

MITEL

3300 IP Communications Platform

ACD Agent/Supervisor Guide for
the Mitel 5330/5340 IP Phones



NOTICE

The information contained in this document is believed to be accurate in all respects but is not warranted by Mitel Networks™ Corporation (MITEL®). The information is subject to change without notice and should not be construed in any way as a commitment by Mitel or any of its affiliates or subsidiaries. Mitel and its affiliates and subsidiaries assume no responsibility for any errors or omissions in this document. Revisions of this document or new editions of it may be issued to incorporate such changes.

No part of this document can be reproduced or transmitted in any form or by any means - electronic or mechanical - for any purpose without written permission from Mitel Networks Corporation.

ACD Agent/Supervisor Guide
for the Mitel 5330/5340 IP Phones

April 2009

®,™ Trademark of Mitel Networks Corporation
© Copyright 2009, Mitel Networks Corporation
All rights reserved

ABOUT THIS GUIDE	5
WHAT IS AUTOMATIC CALL DISTRIBUTION (ACD)?	5
ABOUT YOUR PHONE	6
For Users on Resilient 3300 ICP Systems	9
Mitel Line Interface Module.....	9
TIPS FOR YOUR COMFORT AND SAFETY	10
Don't cradle the handset!.....	10
Protect your hearing	10
Adjust the viewing angle	10
ACD AGENT FEATURES AND CAPABILITIES	11
What are Agent Groups?.....	11
About ACD Agent Hot Desking.....	11
ACD Express Agents	12
Logging In.....	12
Displaying Agent Log-In Information.....	13
Logging Out	13
Answering Calls.....	14
Using the Auto Answer Feature.....	14
Activating Auto Answer.....	14
Deactivating Auto Answer.....	14
Using a Headset	15
Installing a Headset (no Feature Control Switch).....	15
Handling Calls with a Headset (no Feature Control Switch):	15
Installing a Headset with Feature Control Switch	16
Handling Calls with a Headset (with Feature Control Switch):	16
Using and Canceling the Work Timer	17
Taking a Break from Calls (Make Busy Feature).....	17
Activating Make Busy	17
Removing Make Busy.....	18
Group Presence.....	18
Getting Help.....	19

When You Need Help	19
Canceling Help.....	20
Queue Threshold Alert.....	20
Visual Indications	20
Audible Indications.....	20
Queue Status.....	21
When You Need To Know A Group's Queue Status	21
ACD SUPERVISOR FEATURES AND CAPABILITIES	21
What is the Supervisory Position?	21
Queue Threshold Alert / Queue Status.....	22
Silent Agent and Group Monitoring.....	22
Benefits of Silent Monitoring	22
Restrictions to Silent Monitoring	22
Using Silent Monitoring for Individual Agents	22
Using Silent Monitoring for Agent Groups	23
Conferencing	24
Responding to Help	24
What Happens in a Help Request	24
System Reporting Capabilities.....	25
Time Events Records	25
Call Events.....	25
Path and Group Statistics Events.....	26
Station Message Detail Recording (SMDR)	26
Personal Directory.....	27

About this Guide

This guide describes operation of the Automatic Call Distribution 2000 Feature Package on a Mitel® IP phone. For operation of other features associated with Mitel IP phones (some of which will work in conjunction with ACD), refer to the set guide.

What is Automatic Call Distribution (ACD)?

The Automatic Call Distribution (ACD) Feature Package is offered by the Mitel 3300 Integrated Communications Platform (ICP). ACD is a method of switching large volumes of similar calls directly to a selected group of extensions (Agents). All calls are distributed equally among the Agents. The calls are all of a similar nature, and the Agents are trained to provide the particular information or service the caller is requesting.

Typical examples of ACD applications include:

- airline reservation offices
- telephone order desks for large retail stores
- customer service departments of telephone or cable T.V. companies

When there are more incoming calls than available Agents, the calls may be routed to recordings. The recordings may advise the callers that all Agents are busy, and that an Agent will answer as soon as possible. Various recordings may be provided to inform the caller as to call progress if an Agent is not accessed immediately, or to advise the caller of information the Agent will require when connection is established.

The Mitel 3300 ICP also distributes calls to the Agents so that all Agents are given an equal workload. A Supervisor usually oversees the operation, monitors the activity of the Agents, and handles unusual situations that may arise.

About Your Phone

The Mitel® 5330 and 5340 IP Phones are full-feature, dual port, dual mode enterprise-class telephones that provide voice communication over an IP network. They both feature a large graphics display (160 x 320) and self-labeling keys. The 5330 IP Phone offers 24 programmable multi-function keys; the 5340 IP Phone offers 48 programmable multi-function keys for one-touch feature access. Both phones provide ten fixed feature keys for convenient access to features such as Conferencing, Redial, and many customizable user settings as well as navigational keys to access various screens and application layers. The 5330 and 5340 IP Phones also feature a PC Companion application, which is a PC-based desktop programming tool that allows you to easily configure your phone from your Personal Computer (PC).

The 5330 and 5340 IP Phones support Mitel Call Control (MiNet) protocol and session initiated protocols (SIP). Both phones support the Line Interface Module and 5310 IP Conference Unit. Additionally, they support Hot Desking and Clustered Hot Desking as well as Resiliency. The 5330/5340 phones are ideal for executives and managers, and can be used as an ACD Agent or Supervisor Phone, as well as a Teleworker Phone.



NN0220







The 5330 IP Phone



NN0218

The 5340 IP Phone

Elements of Your Phone	
Feature	Function
1) Display	Provides a large, high-resolution viewing area that assists you in selecting and using phone features.
2) Ring/Message Indicator	Flashes to signal an incoming call and to indicate a message waiting in your voice mailbox.
3) Volume, Speaker and Mute Controls	<p>Provide the following audio control capability:</p> <p> (UP) and (DOWN) provide volume control for the ringer, handset, and handsfree speakers.</p> <p> (SPEAKER) enables and disables Handsfree mode.</p> <p> (MUTE) enables Mute, which allows you to temporarily turn your phone's handset, headset or handsfree microphone off during a call.</p>

Elements of Your Phone	
Feature	Function
4) Fixed Function Keys	<p>Give you access to the following phone functions:</p> <p> (APPLICATIONS): provides access to menus for your phone's applications and settings.</p> <p> (CANCEL): ends a call when pressed during the call, and, when you are programming the phone, eliminates any input and returns to the previous menu level.</p> <p> (REDIAL): calls the last number dialed.</p> <p> (HOLD): places the current call on hold.</p> <p> (TRANS/CONF): initiates a call transfer or establishes a three-party conference call.</p> <p> (MESSAGE): provides access to your voice mailbox and flashes to notify you of messages waiting in your voice mailbox. Note: The Ring/Message indicator also flashes when messages are waiting.</p>
5) Keypad	Use to dial.
6) Navigation Page Keys	Use to display additional pages of information. The 5330 has two page navigation keys: Back and Next. The 5340 has three page navigation keys: Back, Next, and Home.
7) Programmable Feature Keys and Softkeys.	Provides 24 (on the 5330) and 48 (on the 5340) self-labeling keys that can be programmed as speed call keys, fixed function keys, hard keys, applications, or line appearance keys, according to your communication needs. On your home page, the bottom right feature key is always your Prime Line key on a 5340 IP Phone; and the bottom left feature key is always your Prime Line key on the 5330 IP Phone. The top three keys are softkeys.
8) Handsfree Speaker	Provides sound for Handsfree calls and background music.
9) Handset	Use for handset calls. If you are in headset or handsfree mode, you do not need to use the handset.

Ring/Message Indicators	
When indicator is	it means that
Flashing rapidly	Your phone is ringing
Flashing slowly	A message or callback message is waiting at your phone
On	Your phone is ringing another phone
Off	Your phone is idle, or you are on a call

For Users on Resilient 3300 ICP Systems

If during a call, you hear a beep repeated every 20 seconds it means that your phone is switching to a secondary 3300 ICP system. The call continues and there is a change in the operation of some keys and features on your phone. Normal operation resumes when your phone switches back to the primary system. If your phone is idle and switched to the secondary system, you'll see a flashing rectangle on the display. The rectangle remains until the switch to the primary system is complete.

If the phone fails over to the secondary ICP, you have access to your mailbox on the secondary ICP only if your Administrator has programmed a mailbox for you.



Notes:

- The mailbox on the secondary ICP will not contain the same messages as the mailboxes on the primary ICP. Any preferences that are voice mail related are not carried from the primary ICP to the secondary ICP. These preferences must be set on both ICPs.
- The *People* and *Settings* applications do not support resiliency. Your logs, contact information and any Settings on the primary ICP will not be carried from the primary ICP to the secondary ICP.

Mitel Line Interface Module

The Line Interface Module is an optional device that adds an analog phone line (POTS) capability to your phone. If Emergency Call Routing is not programmed on your 3300 ICP, you must use the Line Interface Module to dial emergency calls. For more information on emergency number dialing, refer to *Emergency Calls*. If you have a Line Interface Module connected to your phone, all programming of the Line Interface Module, except the Analog Key, is done by the Installer when your phone is installed. For more information, refer to [Programming Features on Your Keys](#) and [Using the Line Interface Module](#).

Tips for Your Comfort and Safety

Don't cradle the handset!

Prolonged use of the handset can lead to neck, shoulder, or back discomfort, especially if you cradle the handset between your ear and shoulder. If you use your phone a lot, you may find it more comfortable to use a headset. See the section on headset usage elsewhere in this guide for more information.

Protect your hearing

Your phone has a control for adjusting the volume of the handset receiver or headset. Because continuous exposure to loud sounds can contribute to hearing loss, keep the volume at a moderate level.

Adjust the viewing angle

The stand built into your phone tilts to give you a better view of the keys.

To tilt your telephone for better viewing:

1. Turn the phone so that the front faces away from you.
2. Hold the base unit firmly and press the release tabs on the sides of the stand to detach the base unit.
3. Hinge the hooks of the base unit into the notches on the back of the phone and snap into place as follows:
 - a. For a high-angle mount, hinge the two lower hooks into the bottom set of notches and snap the two upper hooks into the middle set of notches.
 - b. For a low-angle mount, hinge the two lower hooks into the middle set of notches and snap the two upper hooks into the top set of notches.

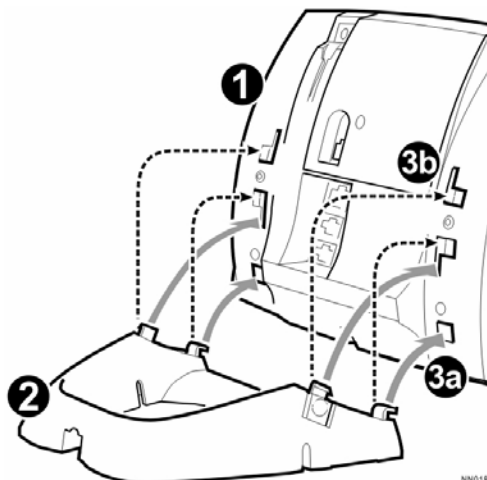

ACD Agent Features and Capabilities

What are Agent Groups?

Traditional ACD agents or hot desk ACD agents may be grouped together based on skill level or department to handle incoming telephone calls in an organization; for example, sales or engineering, or first- or second-level support. Callers are then directed to the Group that best serves their needs. The formation of ACD Agent Groups with two or more Agents in each Group allows calls to be handled on a Group basis rather than on an individual basis. An Agent can have multiple Agent IDs, but Agents can login to only one Agent ID per telephone.

Traditional agent groups or hot desk ACD agent groups are assigned a unique 3-digit reporting number as well as an Agent Group directory number. You will use both of these numbers as discussed throughout this guide.

Agent groups can also be programmed to overflow between each other. This means that if activated, calls that are directed to one Agent Group can be programmed to overflow to other Agent Groups if the first Group was unavailable due to being in an overload condition. This overflow capability allows ACD calls to be handled, even though an Agent Group has been set in a Do Not Disturb mode.

ACD Express Groups associate agents into one skill group, but take advantage of ACD Path features. ACD Express Groups have limited support for RADs, embedded media for music on hold, Interflow, and resilience.

You can have your set programmed to receive additional information concerning Group activity. This information is called Queue Threshold Alert and Queue Status.

About ACD Agent Hot Desking

The ACD Agent Hot Desking feature allows you to log into any hot desk enabled set or ACD enabled set and the system automatically configures the set with your personal speed calls, features, and phone settings. The system also associates your personal phone settings, such as directory number, system settings, language display, and button programming with the set.

For example, you could log into a hot desk enabled set or ACD enabled set, dial a number, and the system stores that number against the **Redial** key for your set profile. After logging out, if you log into another hot desk enabled set or ACD enabled set, you can press the **Redial** key to dial the last number that you had dialed previously while you were logged into the other set.

After logging in as a hot desk ACD agent, you can use the following personal phone features and change the following settings:

- Call forwarding (all types)
- Callback messages (message waiting indicator)
- Auto Answer
- Do Not Disturb (DND)
- Last Number Redial
- Timed Reminder

- Triple Ring Callbacks
- Advisory Status Message
- Group Presence



Note: Hot Desk ACD agents that are not programmed in any groups do not consume an ACD license when they log in.

ACD Express Agents

An ACD Express Agent is hot desk ACD agent. A hot desk ACD agent becomes an ACD Express Agent on an ICP when the first group in which it is programmed is an ACD Express Group.

ACD Express Agents have the same behaviors as hot desk ACD agents, except that ACD Express Agents:

- never consume an ACD license. They consume a User license at provisioning time. Resilient ACD Express Agents consume the user license on the primary ICP.
- can be members of ACD Express Groups.
- can be members of up to eight different ACD Express Groups.
- cannot be members of ACD 2000 Agent Skill Groups.

Logging In

Automatic Call Distribution (ACD) calls are directed to Logged In Agents only. ACD calls are not directed to a telephone where there is no Agent Logged In. You can log in by following the procedure described below.

An important concept in the ACD system for you to be aware of is agent mobility. As an Agent, you are assigned a 1- to 7-digit Identification (I.D.) number to log in with. You can be called by this I.D. number, as well as by the telephone extension number where you are working. This means that you can be called by your I.D. number regardless of where you may be located. For this reason it is also a good idea for your Agent I.D. number to be included in your company's telephone directory.

As an Agent, you can belong to multiple groups. When you log in using your Agent I.D., you are automatically logged in to all groups in which you are a member. Check with your manager if you do not know the ACD Log-In access code or do not have an I.D. number. The Agent I.D. number is unique to each Agent, and allows the system to distribute ACD calls to Logged In Agents. An Agent can stay logged in indefinitely on the same telephone. You can also log in by using a special Feature Access code not explained in this guide.



Note: If the I.D. is invalid, the display shows an INVALID error message and the Log-In procedure is terminated. If the I.D. is in use by another Agent, the display shows a USED BY error message and your Log-In attempt is terminated. If an Agent Log-In code is dialed, but no I.D. is entered within 60 seconds, the Log-In procedure is not activated and your set is treated as a Logged Out set.

After you have logged in, you can display your Log-In information. See "Displaying Agent Log-In Information" for further details.

If you are a traditional ACD agent, you require your Agent ID to log in; if you are an ACD Express or ACD hot desk agent, you require your Agent ID and your User Personal Identification Number (PIN).

Note: You will need to program a **SuperKey** feature key on your set.

To log in as a traditional agent:

4. Press **SuperKey**. "Agent Login?" is displayed.
5. Press the **Yes** softkey.
6. Dial your Agent ID number and press **Enter**.

To log in as a hot desk ACD agent or ACD Express agent:

1. Press the **HotDesk** softkey. "No User Logged In" appears in the display.
2. Press the **Login** softkey. "Enter your Ext#" is displayed.
3. Dial your Agent ID number and press **OK**. "Enter your PIN" appears.
4. Enter your PIN and press **OK**.

Displaying Agent Log-In Information

It is possible to display and verify Log-In information when you are logged in to a set. The information displayed is the Agent I.D. number logged in to that set. To display agent log-in information:

1. Press **SuperKey**.
2. Press the **No** softkey until PERSONAL KEYS appears on the display.
3. Press the **Yes** softkey. The Agent Identification (I.D.) number currently logged in will be displayed for 3 seconds
4. The prompt SELECT A KEY appears. You may select another Line Select Key for similar information if the set has more than one line appearance.

If you press your Prime Line Key, your display shows your Agent I.D. number and your name (if programmed).

5. To exit, press **Cancel**.

Logging Out

Logging out returns the set to Make Busy and it no longer receives Automatic Call Distribution (ACD) calls, since ACD calls are directed to Logged In telephones only. Your set operates normally for non-ACD use when logged out.

Logging Out can be activated during a call in progress, and takes effect only when you terminate (hang up) the call. This allows you to activate this feature before your set can ring again for another call.

To log out

1. Press **SuperKey**.
2. Press **No** until AGENT LOGOUT? appears in the display.
3. Press **Agent Logout**. You are now logged out. After a few seconds, LOGGED OUT appears on the display.



Note: If you log out of an agent session while a call is in progress, "LOGGED OUT" will not appear in the display until the call is ended.

Answering Calls

Answering ACD calls is not unlike answering regular calls. When the telephone rings, you will see the indicator beside your Line Select Key flash. To answer the call, pick up the handset and begin speaking.

A headset option can be programmed into your system, eliminating the need to pick up the handset. A headset is helpful in high call traffic situations normally encountered in an ACD environment. For instructions on how to use a headset, see "Using A Headset" and "Using the Auto Answer Feature".

Using the Auto Answer Feature

You may prefer to answer your calls automatically using the Auto Answer feature, for either handset or headset operation. If this feature is enabled, after you receive a call you hear one short ring before being automatically connected to the caller. Never leave your telephone unattended while the Auto Answer feature is turned on.

Activating Auto Answer

To activate the Auto Answer feature

1. Press **SuperKey**.
2. Press **No** to scroll until AUTO ANSWER? appears on the display.
3. Select **Turn On**. Auto Answer is now activated and AUTO ANSWER appears on the display.

Deactivating Auto Answer

To deactivate Auto Answer

1. Press **SuperKey**.
2. Press **No** until AUTO ANSWER? appears on the display.
3. Select **Turn Off**. Auto Answer is deactivated and AUTO ANSWER disappears from the display.

Using a Headset

Your system administrator may have enabled full-time headset operation on your telephone. Telephones with full-time headset operation enabled must be operated only with headsets.

Telephones that are not programmed for full-time headset operation should be programmed with a **Headset** feature key to allow you to switch between handset and amplified headset (no feature control switch) operation.

Switching between handset and headset mode when using a Headset with Feature Control Switch can be accomplished by connecting or disconnecting the headset at the quick-disconnect plug on the headset cord, but you should also disable headset operation if the handset will be used for an extended period of time.

A headset can be used either in regular answer mode or with the Auto Answer feature programmed.

Most headsets are installed using the same jack that the handset plugs into. Mitel Headsets with Feature Control Switch (PN 9132-800-500-NA/9132-800-501-NA) plugs into the dedicated headset jack (the jack nearest the front of the set).

Installing a Headset (no Feature Control Switch)

To install the headset for your use

1. When the telephone is not in use, lift the handset from the cradle and carefully turn the set upside down.
2. Unplug the handset cord where it connects to the telephone.
3. Plug in the headset cord in the same place.
4. Set the telephone upright and return the handset to the cradle
5. Press the **Headset** feature key.
6. Store your handset in a safe place.

To return to handset operation

1. When the telephone is not in use, lift the handset from the cradle and carefully turn the set upside down.
2. Unplug the headset cord where it connects to the telephone.
3. Plug in the handset cord in the same place.
4. Set the telephone upright and return the handset to the cradle.
5. Press the **Headset** feature key.
6. Store your headset in a safe place.

Handling Calls with a Headset (no Feature Control Switch):

To answer a call (when Auto Answer is disabled):

- Press the flashing Line Select key.

To hang up:

- Press .

Installing a Headset with Feature Control Switch



IMPORTANT NOTE: Mitel Headsets with Feature Control Switch (PN 9132-800-500-NA/9132-800-501-NA) must be installed in the dedicated headset jack (the jack nearest the front of the set). Installation will disable your handset microphone. Disconnecting the headset at the jack or at the quick-disconnect plug restores handset operation.

To install the headset for your use, perform the following tasks:

1. When the telephone is not in use, lift the handset from the cradle and carefully turn the set upside down.
2. Plug the headset cord into the headset jack (the jack nearest the front of the set).
3. Set the telephone upright and return the handset to the cradle.
4. Press the **Headset** feature key.

To return to handset operation

1. When the telephone is not in use, lift the handset from the cradle and carefully turn the set upside down.
2. Unplug the headset cord where it connects to the telephone.
3. Set the telephone upright and return the handset to the cradle.
4. Press the **Headset** feature key.
5. Store your headset in a safe place.

Handling Calls with a Headset (with Feature Control Switch):

To answer a call (when Auto Answer is disabled):

- Press the flashing Line Select key
-or-
Quickly press and release the Feature Control Switch.

To mute the headset microphone:

- Press and hold the Feature Control Switch.

To hang up:

- Press 
-or-
Quickly press and release the Feature Control Switch.

Using and Canceling the Work Timer

The Work Timer provides a delay after each ACD call, before the next call is directed to you. This gives you a certain amount of time to complete any work generated by the previous call.

The Work Timer is automatic and you are not required to perform any procedures to activate it. The length of time provided by the timer varies from 0 to 600 seconds, and is programmed only by the System Administrator.

Work Timers apply to ACD Agents and ACD calls only. Other calls to and from your set do not activate a Work Timer. If the Make Busy or Do Not Disturb features are activated at your telephone, the Timer is cancelled for that call.

Once you terminate an ACD call, WORK TIMER appears on the display for the duration of the Work Timer period.

When the Work Timer expires, WORK TIMER disappears from the display and you are ready to take another call.

You have the option of canceling the Work Timer and accepting another call before the Timer expires. Cancellation of the Timer affects only the next ACD call.

To cancel the Work Timer, press the  key. Your set displays the normal screen and is now available for the next ACD call.

Taking a Break from Calls (Make Busy Feature)

Activate the Make Busy feature to stop receiving Automatic Call Distribution (ACD) calls at your set for relatively brief periods of time, thereby avoiding the need to log out and subsequently log in again. Make Busy ensures that your ACD set does not receive calls while you are unavailable to handle the calls.

Your Mitel IP Phone operates as a normal telephone except for ACD use during the Make Busy state. You can activate this feature during a call in progress. The Make Busy state commences upon completion of that call. This allows you to activate this feature before your set can ring again for another call.



Note: Your System Administrator can configure the system to automatically place your set in Make Busy when you log in. In this case, you must remove Make Busy before you can start taking ACD calls.



Note: You will need to program a **SuperKey** feature key on your set.

Activating Make Busy

To activate the Make Busy feature:

1. Press **Superkey**.
2. Press **No** until MAKE BUSY? appears on the display.
3. Press **Make Busy**. Your set displays MAKE BUSY until you deactivate it.

Removing Make Busy

To deactivate the Make Busy feature:

1. Press **Superkey**.
2. Press **No** until MAKE BUSY? appears on the display.
3. Press **Clear Busy**. Make Busy is removed from your set.

Group Presence

Group Presence allows members of an ACD Group to make themselves “absent” or “present” in a group. Only members who are present in a group are offered calls to that group.

Users belonging to multiple groups can control their presence in each group separately through the use of feature keys (one for each group), or by dialing a feature access code (FAC) followed by the group number.

Supervisors can also dial a FAC from their phone to change the presence status of an agent.

To join an ACD group:

1. Lift the handset.
2. Do one of the following:
 - Press the Group Presence Feature key to join the group associated with the key.
 - Dial the Group Presence - Join Group feature access code followed by the group directory number.

The LED associated with the key is steady lit when the member is present and off when absent.

To leave an ACD group:

1. Lift the handset.
2. Do one of the following:
 - Press the Group Presence Feature key to join the group associated with the key.
 - Dial the Group Presence - Leave Group feature access code followed by the group directory number.

The LED associated with the key is steady lit when the member is present and off when absent.

To join all ACD groups:

1. Lift the handset (optional on devices that support on-hook dialing).
2. Dial the Group Presence - Join All ACD Groups feature access code.

To leave all ACD groups:

1. Lift the handset (optional on devices that support on-hook dialing).
2. Dial the Group Presence - Join All ACD Groups feature access code.

To change another group member's presence status:

1. Lift the handset.
2. Dial the Group Presence - Join Group Third Party or Group Presence - Leave Group Third Party .
3. Dial the directory number of the group member.
4. Dial the group directory number.

Getting Help

Whenever you are in a conversation on an Automatic Call Distribution (ACD) call, you can request help from an ACD Supervisor. The type of help you receive initially is to have the Supervisor silently monitor the conversation. The caller is not aware that they are being monitored unless the Supervisor later decides to initiate a three-way conference, which can be done at any time during the call.

If a Supervisor has not logged in with an Agent Identification (I.D.) code, the Supervisor's extension number must be dialed (when prompted to do so). If a Supervisor has logged in with an Agent I.D. code, you can request help without having to know the location, by dialing that Agent I.D. code (when prompted to do so).

A Supervisor's I.D. code or extension number can be dialed by using either the keypad or by having a Speed Call Key programmed for this purpose.

When You Need Help

To request help:

1. Press **SuperKey**.
2. Press the **No** softkey until REQUEST HELP? appears on the display.
3. Press the **Yes** softkey.
4. You will be prompted to enter the extension number of the Supervisor you want.

Your help request is automatically cancelled if you do not enter digits within 20 seconds. Digits dialed in error can be erased with the **←** Softkey.

The **←** and **Enter** softkey will appear after you start entering the digits.

5. Press the **Enter** softkey. Your display shows the path name, then updates to show originating party information, including the amount of time that the caller has waited.

6. If the Supervisor is busy, the display shows BUSY (allowing you to make another choice or to cancel your request for Help).
7. When the Supervisor answers, the display indicates HELP accompanied by the Supervisor's number or name.

If the Supervisor conferences into the call, a **Split** Softkey also appears.

8. When the Supervisor hangs up, the display returns to idle.

Canceling Help

While waiting for the Supervisor to respond to your Help request, you can cancel the Help request before it is answered by pressing . This cancels the request and you are prompted to enter a second help number, if desired. Your Help request is automatically cancelled if you do not enter digits.

Queue Threshold Alert

Thresholds are programmed into the ACD system to provide a basis for alerting Agents and Supervisors that calls have waited longer than acceptable limits (thresholds) to be answered.

If your set is programmed with a Generic Group **Queue Status** Feature Key, it can provide a visual indication of the current workload conditions of the Automatic Call Distribution (ACD) Group into which you are logged. Supervisors may have two or more Specific Group **Queue Status** Feature Keys and threshold alerts, allowing them to monitor activity in more than one Group. Your set may also be programmed to provide an audible alert that Queue Status has changed.



Note: Agents in the Logged Out, Do Not Disturb, or Make Busy states are not considered active Agents for the purpose of Queue Threshold Alert.

Visual Indications

If your set is programmed to provide a visual alert, the indicator beside the **Queue Status** Feature Key indicates the three levels of alert as follows:

- a solid indicator beside the Line Select Key on your set indicates that the workload is below the first threshold limit programmed
- a slowly flashing indicator indicates that the workload is above the first but below the second threshold limit programmed
- a quickly flashing indicator indicates that the workload is above the second threshold limit programmed.

Audible Indications

For sets programmed for audible indications, the system provides the following different ringing patterns, depending on the threshold alert status:

- a single ring occurs when the longest waiting caller exceeds the programmed first threshold time interval
- a double ring occurs when the longest waiting caller exceeds the programmed second threshold time interval

- a single or double ring occurs when a previous threshold time interval is reverted to (i.e., when the longest waiting call is answered and the next longest waiting caller is in a different threshold level).

Queue Status

Agents may access the following queue-status information about their Group (Supervisors may query more than one Group):

- the number of active Agents in the Group
- the number of calls waiting for the Group (queue)
- the length of time that the longest call has been waiting for the Group.



Note: Agents in the Logged Out, Do Not Disturb, or Make Busy states are not considered active Agents for the purpose of Queue Status.

When You Need To Know A Group's Queue Status

- If your set is programmed with a Generic Group **Queue Status** Feature Key, press the key (for Supervisors, press the appropriate Specific Group **Queue Status** Feature Key).

ACD Supervisor Features and Capabilities

What is the Supervisory Position?

An Automatic Call Distribution (ACD) Supervisor supervises one or more Agent Groups. The system administrator programs a supervisor's telephone or hot desk user profile with additional features and keys that allow the supervisor to monitor ACD group activities. Supervisors do not have to log in at their phone in order to monitor ACD group activities.

Several management and reporting statistics and information can be produced by the 3300 ICP, but are beyond the scope of this guide. Supervisors should consult with the System Administrator concerning the availability of other management tools.

The following Supervisor functionality is described in this section:

Queue Threshold Alert / Queue Status describes the meaning of threshold alert indicators and the means of accessing queue information for specific groups.

Silent Agent and Group Monitoring describes the procedure for silently listening to Agents' calls, and lists the benefits of and restrictions to this feature.

Conferencing describes the procedure for joining into a three-way conversation with an Agent and a caller under Silent Monitor.

Responding to Help describes the procedure for answering a Help request made by an Agent.

System Reporting Capabilities briefly describes the two types of reports that can be produced by the feature package. These reports can be used by management to study the effectiveness of the ACD operation:

- Real Time Events Records
- Station Message Detail Recordings.

Queue Threshold Alert / Queue Status

Supervisors may need to be alerted when any of two or more Agent Groups have exceeded programmed limits. For this reason, Supervisors may have two or more Specific Group **Queue Status** Feature Keys programmed on their set, each dedicated to a different Group's activities. Their operation and the alerts associated with them are the same as Generic Group **Queue Status** Feature Keys, which are detailed in "Queue Threshold Alert" and "Queue Status" in the Agent Features and Capabilities section of this guide.

Silent Agent and Group Monitoring

Silent monitoring allows you to listen to conversations between Agents and ACD callers, or between Agents and ACD callers in conference with a third party, in one or more Agent Groups.

Benefits of Silent Monitoring

Silent monitoring can be done either with or without an Agent's knowledge, depending on how this feature was set up by your System Administrator. If Agent notification has been programmed, the Agent you are monitoring will receive a Conference tone at the start of the monitoring period. Agents can only be monitored by one Supervisor at a time. When you are monitoring an Agent, neither the Agent nor the ACD caller can hear you. During Agent monitoring, you can join into the conversation by initiating a "Conference" as described later in this guide.

Restrictions to Silent Monitoring

- While monitoring, you cannot be interrupted by previously-activated features such as Camp On or Callback.
- During monitoring, you temporarily lose Hard Hold, Soft Hold, and Phonebook features.
- A call cannot be transferred to you while you are monitoring.
- An Agent who has a call on Soft Hold cannot be monitored.
- You cannot commence Agent monitoring if you have a call on hold.
- cannot monitor calls that are directed to a recorded announcement until the ACD caller has been answered by an Agent.
- If you establish a conference during Silent Monitoring, you will not be placed automatically in Silent Monitor mode once the conference has ended. You must start over and re-establish Silent Monitoring following termination of the Conference.
- If you are responsible for monitoring more than one Agent Group, you must exit the Silent Monitor feature for the Group you are presently monitoring and then re-establish it for the next Group you want to monitor.

Using Silent Monitoring for Individual Agents

Silent Monitoring can be performed on- or off-hook.

To establish this type of Silent Monitor, perform the following tasks:

1. Lift the handset and listen for dial tone, if off-hook operation is desired. Otherwise, skip this step.
2. Press the **Monitor** Softkey.
3. Enter the Agent Identification (I.D.) Number or Extension number of the Agent you want to monitor. When you start to enter the number, a ← arrow appears. Use the ← Softkey to change incorrect entries.

If no conversation is taking place, you will hear silence, and the display will show the Extension number followed by WAITING.

If a conversation is in progress, or begins, you will hear a conference tone prior to the conversation, and the display will show the Extension number and the Agent's name.

When the conversation ends you receive Conference tone followed by silence until the next conversation begins. To join the conversation being monitored, refer to "Conferencing" later in this guide.

4. To exit Silent Monitoring, hang up your handset or press .

Using Silent Monitoring for Agent Groups

Silent Monitoring can be performed on- or off-hook.

To establish this type of Silent Monitor, perform the following tasks:

1. Lift the handset and listen for dial tone, if on-hook operation is desired. Otherwise, skip this step.
2. Press the **Monitor** Softkey.
3. Enter the Agent Group Number you want to monitor. If no conversations are taking place in the Group, you will hear silence and the display will show the Group number, followed by WAITING.

If a conversation is in progress or begins, you will hear Conference tone prior to the conversation, and the display will show the Group number and the name of the Agent.

When the conversation ends you will receive Conference tone followed by silence until the next conversation begins. To join the conversation being monitored, refer to "Conferencing" later in this guide.



You may monitor a different Agent in the Group by pressing the ← Softkey. There is a brief period of silence between the removal of the first monitor and the creation of the second. When the ← Softkey is pressed, and there are no other conversations in the Group, you are returned to the original conversation.

4. To exit Silent Agent Group Monitoring, hang up your telephone or press .

Conferencing

This feature allows you to join into a conversation that is being monitored. You, the Agent, and the ACD caller are joined in conversation. All parties hear the Conference tone when you start the Conference.

To start a Conference

1. Establish a Silent Agent or Group Monitor as explained in "Silent Agent and Group Monitoring".
2. Press the  key to join the conversation. Silent Monitoring ends when the Conference begins.
3. To exit the Conference, hang up your telephone or press . Following termination of a Conference you must start over and re-establish Silent Monitoring as described in "Silent Agent and Group Monitoring".

Responding to Help

As a Supervisor, Help requests are made to you by Agents under your supervision. These Help requests are initially for you to silently monitor a conversation in progress. Once you are monitoring your Agent and a caller they are in conversation with, you have the ability to remove your Silent Monitor and actively join the conversation in progress. You also have the option of discontinuing the Silent Monitor mode that was established when you responded to the Help request.

Help requests override any Call Forwarding, Do Not Disturb, or Re-routing that may have been established on your set. A Help request does not respond to Call Pickup from other sets.

If you are currently monitoring an Agent who requests Help from you, a delay of 5 seconds takes place at the Agent's set prior to the Agent's indication that Help is in progress. This is done so that the Agent doesn't necessarily know that monitoring was in progress.

If you are monitoring an Agent that requests Help from a Supervisor other than yourself, you receive a Conference tone, are temporarily removed from your monitor status, and return to the WAITING display on your set. This Conference tone indicates that this is not the normal completion of a call. When this Help session is completed, the original monitor is re-created and you receive Conference tone again to indicate that the active monitor condition has resumed.

If you have logged in as an Agent in addition to your supervisory role, Agents are able to request Help from you without knowing your location by using your Log-In I.D. number. This allows you to move freely from station to station. If you decide to log out during a Help or Silent Monitor session, the Log Out does not affect the session in any way until you hang up.

What Happens in a Help Request

When you receive a Help request from an Agent, your set emits a triple ring. HELP is displayed, followed by the Extension number and name (if programmed) of the Agent requesting Help.

To respond to the Help request:

1. Pick up your handset. Your set automatically goes into Silent Monitor mode and you hear the conversation in progress. HELP disappears from your display, but the Extension number and name (if programmed) remains displayed.

At any time during monitoring, you can either initiate a Conference or exit from the Help mode.

To initiate a Conference, press the  key on your set. The display shows CONFERENCE and Conference tone is sent to the Agent only. You are now in Conference with the Agent and any other callers they are speaking to.



Note: Split allows you to break the conference and redirect the call to another party.

2. To exit from Help or Conference modes, hang up your telephone.

System Reporting Capabilities

The 3300 ICP is capable of producing many reports that can be used as management tools to study the effectiveness of the ACD operation. These reports may be presented in a variety of ways based on the software package used to generate them.

The categories of reports that pertain to ACD are Real Time Events Records and Station Message Detail Recordings (SMDR). It is beyond the scope of this guide to discuss these reports in detail, but a brief description of them is included to summarize their intended use.

Time Events Records

Real Time Events Records are used to record the activity of the entire ACD operation, and are available from the System Administrator. These records are divided into two groups: Call Events and Group and Path Statistics Events. Call Events report on individual ACD Agent activity, while Group and Path Statistics Events provide a cumulative report on Group and Path status.



Note: Real time events are not recorded for ACD Express Groups.

Call Events

As traditional and hot desk ACD Agent activities occur, a report is generated to show the following:

- Work Timer Start Event: Indicates the start of the timer, for an agent's set with Work Timer programmed. Work timers are given only for answering ACD 2000 calls.
- Work Timer End Event: Signifies the end of the Agent's Work Timer, for both normal timer expiration, and timer cancelled by Agent.
- Answer Personal Call: Signifies the Agent answering a personal call, i.e., a non-ACD 2000 call.
- Originate Call Event: Signifies the Agent entering a conversation.
- Agent Idle Event: Signifies the Agent completing a personal call or, if no Work Timer is programmed on the Agent's set, any call.
- Call Hold Event: Occurs when an Agent puts a call on Hard Hold.

- Call Hold Retrieve Event: Occurs when an agent retrieves a call from Hard Hold.
- Call Hold Abandon Event: Occurs when an Agent's held party clears down (i.e., is answered) while on hold.
- Agent Log-In: Records each time an Agent successfully logs in.
- Agent Log Out: Records each time an Agent successfully logs out.
- Set Do Not Disturb (DND): Records each time a set is placed in the DND state.
- Remove DND: Records each time a set is removed from DND state.
- Set Make Busy: Records each time a set is placed in Make Busy state.
- Remove Make Busy: Records each time a set is removed from the Make Busy state.
- Answering Incoming ACD Calls: Records each time an Agent answers an ACD call that was directed to a Path, and includes the Agent I.D. number, extension number and Path Reporting number
- Agent Idle: Records the time when the Agent Work Timer expires or was cancelled. If the Work Timer is not in effect, the end of each call or the start of the Work Timer is recorded.

Path and Group Statistics Events

The Group and Path Statistics Events provide a cumulative report on Group and Path status. The events are generated once every 15 seconds (less frequently under high-traffic environments) for those Paths and Groups programmed to report statistics events. One additional event, a Refresh Reports event, is generated to signify the start of each new cycle of Path and Group Statistics events.

Station Message Detail Recording (SMDR)

SMDR contains additional details about call re-routing and call transfer. The following descriptions pertain to ACD-related SMDR reports:

- Time to Answer: Records the total time to answer a call
- Transferred Calls: Records each time a call was transferred
- Digits Dialed Field: For ACD 2000 Groups, SMDR records the ACD Path that was called, each Group the call was presented to, and the Group that answered the call. Paths and Groups are identified by their reporting numbers within the Digits Dialed field. Because ACD Express Agents cannot be programmed in both ACD Express and Agent Skill Groups simultaneously, the group DN and not path numbers is provided in SMDR records.
- Called Party Field: Records the Agent ID of the Agent that answered the ACD Path call.

Personal Directory

Your Extension Number: _____

Your Agent I.D. Number: _____

Your User PIN (required for ACD Hot Desk Agents only): _____

Your Supervisor's Extension Number: _____

Your Group Name/Number: _____

Use this table to record your frequently used numbers.

Name	Number

Use this table to record the feature access codes you are most likely to need on your telephone.

Feature	Access Code
Auto Answer	
Do Not Disturb	
Headset Operation	
Make Busy	



Global Headquarters	U.S.	EMEA	CALA	Asia Pacific
Tel: +1(613) 592-2122	Tel: +1(480) 961-9000	Tel: +44(0)1291-430000	Tel: +1(613) 592-2122	Tel: +852 2508 9180
Fax: +1(613) 592-4784	Fax: +1(480) 961-1370	Fax: +44(0)1291-430400	Fax: +1(613) 592-7825	Fax: +852 2508 9232

For more information on our worldwide office locations, visit our website at www.mitel.com/offices

THIS DOCUMENT IS PROVIDED TO YOU FOR INFORMATIONAL PURPOSES ONLY. The information furnished in this document, believed by Mitel to be accurate as of the date of its publication, is subject to change without notice. Mitel assumes no responsibility for any errors or omissions in this document and shall have no obligation to you as a result of having made this document available to you or based upon the information it contains.

M MITEL (design) is a registered trademark of Mitel Networks Corporation. All other products and services are the registered trademarks of their respective holders.

© Copyright 2008, Mitel Networks Corporation. All Rights Reserved.

www.mitel.com

